

VegaLux®

StudioLED FRESNEL.



VegaLux 300.
StudioLED FRESNEL.



VegaLux 200.
StudioLED FRESNEL.

The Motorized ZOOM 7" Fresnel with a beautiful variable beam light and high TLCI* for professional television and production lighting.

Model	VegaLux 200® Tungsten	VegaLux 200® Daylight
Code	G6LED118	G6LED119
Operation	90-240V - 50/60Hz	90-240V - 50/60Hz
Weight lb/kg	14.00/6.60	14.00/6.60
Electrical draw	1.48A (185W) @120V	1.48A (185W) @120V
Color temperature	3200K	5600K
CRI	+90	+90
Remote dimming control	Via DMX 0% - 100%	Via DMX 0% - 100%
Local dimming control	Digital Display 0% - 100%	Digital Display 0% - 100%
Zoom control	Motorized Local & DMX from 10° - 40°	Motorized Local & DMX from 10° - 40°

Technical specifications

- DMX Dimmable Motorized Zoom 10° to 40° Spot to Flood adjustment.
- Local and DMX Digital Dimmer 0% - 100%.
- Available in 2 color temperatures: Tungsten 3200K or Daylight 5600K.
- 50,000 hours long Life LED.
- Powerful LED engine with very low 185W electrical draw.
- World operation: 90 - 240VAC - 50/60Hz VAC.
- HALODIM® Stepless CCT & Dimming Technology.
- Silent active fan cooling.
- Exclusive NEBULA® Diffusion Chamber Technology for a beautiful high CRI and TLCI* variable beam light for defined shadows & color rendition.

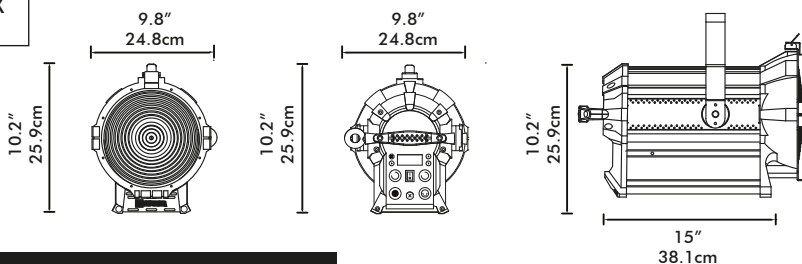

Photometric Data	1.83m (6.00ft)	2.74m (9.00ft)	3.66m (12.00ft)
------------------	----------------	----------------	-----------------

Illuminance E Foot-Candles/lux

VegaLux 200® Daylight

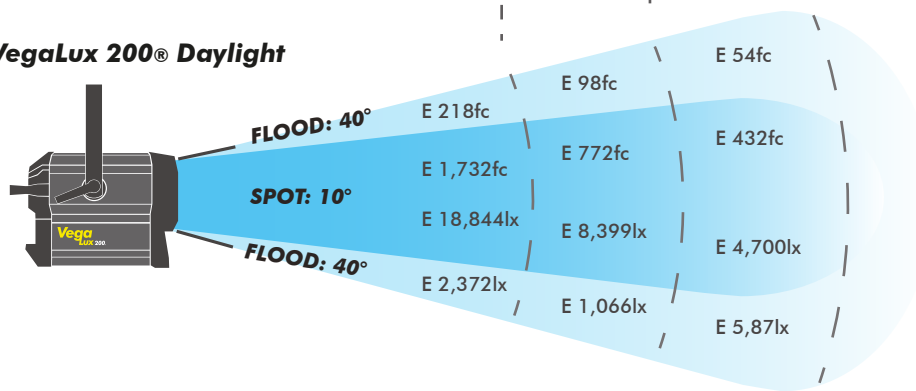

VegaLux 200® Tungsten

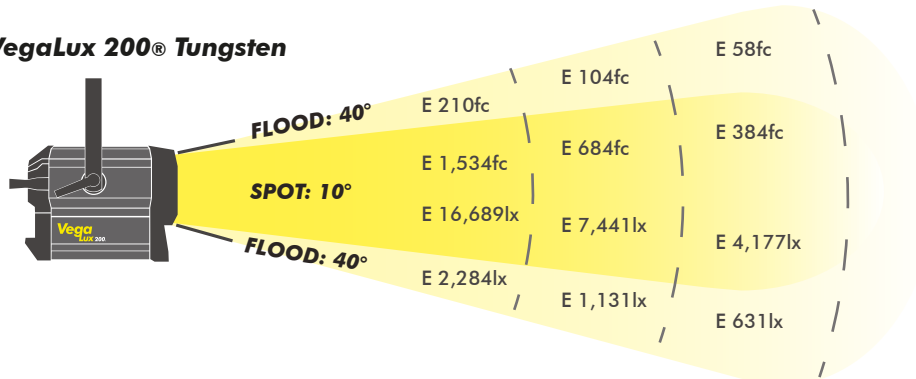

Included accessories

- Barndoors - 8 Blades G6LED121
- Filter Holder G6LED096
- C-Clamp G6FLT262
- Safety Cable G6FLT059
- Locking AC cord POWERCON 5.08ft (1.54m) G6LED125

The Big 12" BiColor Motorized Zoom DMX Dimmable Fresnel with a beautiful variable beam light for professional television and production lighting.

Model	VegaLux 300® BiColor
Code	G6LED126
Operation	90 - 240V - 50/60Hz
Weight lb/kg	16.5/7.5
Electrical draw	2.81A (338W) @120V
Remote variable CCT	3000K - 5800K
CRI	+90
Remote dimming control	Via DMX 0% - 100%
Local dimming control	Digital Display 0% - 100%
Zoom control	Motorized Local & DMX from 15° - 50°

Technical specifications

- DMX Dimmable Motorized Zoom 15° to 50° Spot to Flood adjustment.
- Local and DMX Digital Dimmer 0% - 100%.
- Powerful LED engine with 338W electrical draw.
- Operation Voltage: 90 - 240V - 50/60Hz.
- HALODIM® BiColor® Stepless CCT & Dimming Technology.
- Exclusive NEBULA® Diffusion Chamber Technology for a beautiful high CRI and TLCI* variable beam light for defined shadows & color rendition.

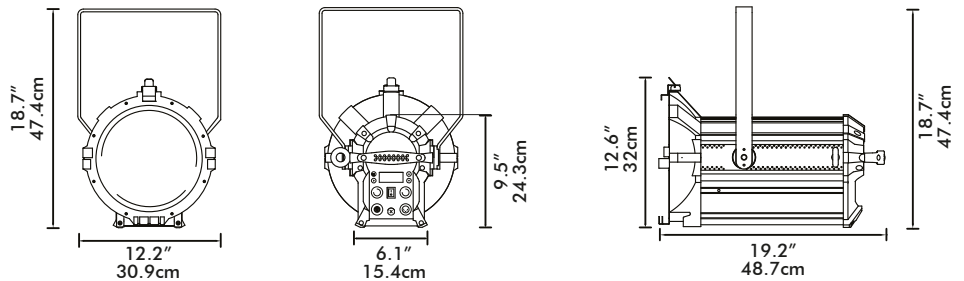

Photometric Data	Distance	1.83m (6.00ft)	2.74m (9.00ft)	3.66m (12.00ft)
------------------	----------	-------------------	-------------------	--------------------

Illuminance E Foot-Candles/lux

VegaLux 300® Neutral White

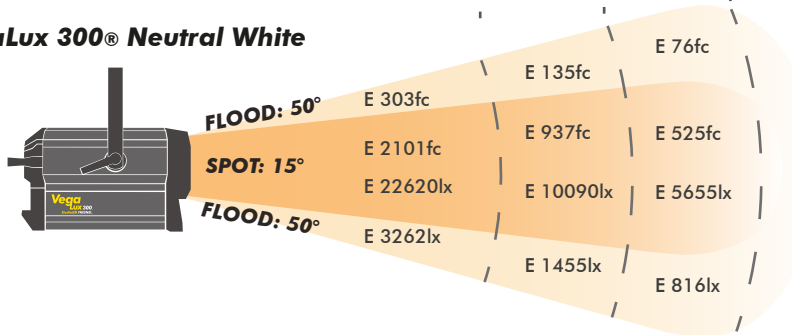

VegaLux 300® Cool White

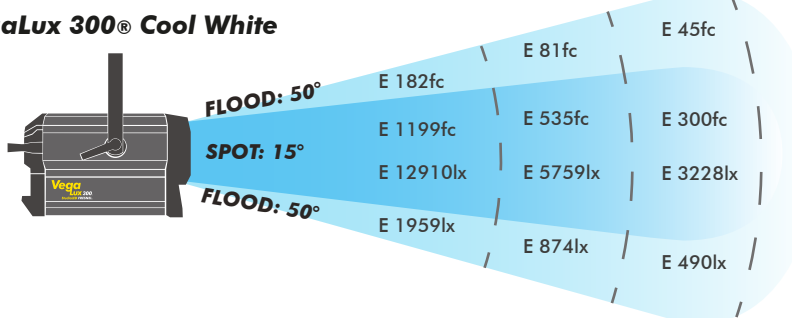

Included accessories



Barndoors - 8 Blades
G6LED127



Filter Holder
G6LED128



C-Clamp
G6FLT262



Safety Cable
G6FLT059



Locking AC cord
POWERCON 5.08ft (1.54m)
G6LED125

VegaLux 300® Warm White

